



modello:
model:

**STAR
ADJUSTABLE DUE**

codice:
code:

6716

design:

UT Egoluce

anno - year:

2022

tipologia:

**faretto orientabile mini trim da
incasso**

tipology:

**adjustable recessed mini trim
spotlight**

materiali:

**corpo in alluminio, riflettore in
policarbonato metallizzato, schermo
in vetro**

materials:

**aluminum structure, metallized
polycarbonate reflector, glass screen**

luce:

d'accento o diffusa

light:

accent or diffuse

sorgente luminosa:

light sources:

LED code	beams	optic	LED color		
/W	/18	/40 /60	LED 6,1W 17,3V 350mA	975lm	4000K
/W/ST	vetro satinato - satin glass		LED 6,1W 17,3V 350mA	975lm	4000K
/WW	/18	/40 /60	LED 6,1W 17,3V 350mA	939lm	3000K
/WW/ST	vetro satinato - satin glass		LED 6,1W 17,3V 350mA	939lm	3000K
/XW	/18	/40 /60	LED 6,1W 17,3V 350mA	896lm	2700K
/XW/ST	vetro satinato - satin glass		LED 6,1W 17,3V 350mA	896lm	2700K

life:

> 50.000 h

step MacAdam:

3

Indice di Resa Cromatica:

>80

Color Rendering Index:

**CRI>90 su richiesta
CRI>90 on request**

grado IP - IP grade:

40

peso netto - net weight:

0,16 Kg

finiture - finishes:

**.01 bianco .01 white
.02 nero .02 black**

marcatura:

marking:

CE

simboli costruttivi:

symbols:



Dimensioni - Dimensions

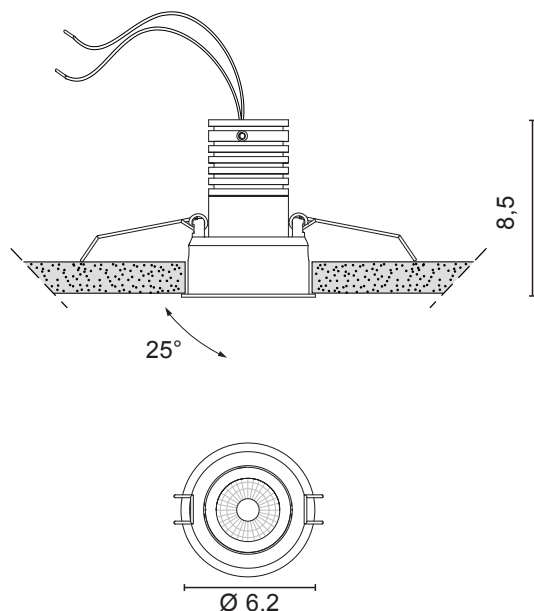

SOLO COLLEGAMENTO IN SERIE - ONLY SERIAL CONNECTION

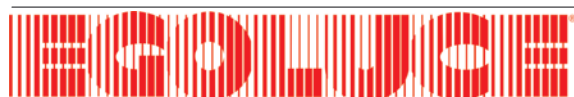

EGOLUCE s.r.l., via I.Newton 12 - 20016 Pero - Milano
telefono +39 02 339586.1 - fax. +39 02 3535112
e-mail: info@egoluce.com - http://www.egoluce.com

Il driver è da ordinare separatamente.

Sono disponibili anche alimentatori dimmerabili con controllo PUSH, 1...10V, DALI o a taglio di fase ed unità di controllo per la luce d'emergenza.

The driver must be ordered separately.

Dimmable drivers with PUSH, 1...10V, DALI o` phase cut-off control and emergency lighting control units are also available.

I drivers **0136/15**, **0125** e **0128** possono passare dal foro di incasso del faretto.
Drivers 0136/15, 0125 and 0128, can pass through the recessed hole of the spotlight.

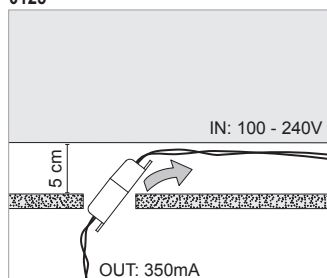
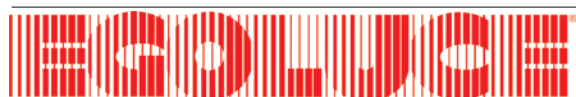
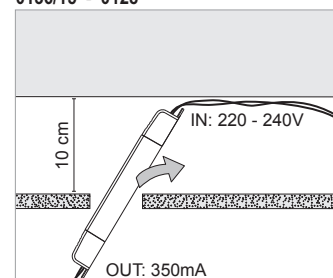
0125**0136/15 - 0128**

EGOLUCE s.r.l., via I. Newton 12 - 20016 Pero - Milano
 telefono +39 02 339586.1 - fax. +39 02 3535112
 e-mail: info@egoluce.com - <http://www.egoluce.com>

LED DRIVERS in corrente continua LED DRIVERS constant current

0125

LED driver

IN: 100 - 240V
OUT: 350 mA
1 COB LED



6 x 3,5 x 2 cm  4 cm

SEL  EUR

0128

LED driver

IN: 100 - 240V
OUT: 350 mA
1-2 COB LED

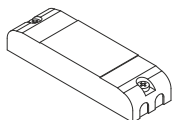

11,6 x 3,4 x 2 cm  4 cm

 05 
SEL. CLASS 2

0136/15

LED driver

IN: 100 - 240V
OUT: 350 mA
1-2 COB LED

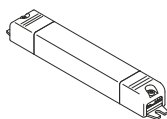

15,8 x 2,2 x 2 cm  3,2 cm

SELV  05 

0169/50

Multipower LED driver

IN: 220 - 240V
OUT: 350mA
1-3 COB LED

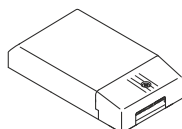

13 x 7,5 x 3 cm  8,5 cm

SELV 

DRIVERS DIMMERABILI in corrente continua DIMMABLE LED DRIVERS constant current

0129 Dimmer LED

Multipower dimmable driver

IN: 110 - 240V
OUT: 350 mA, 1-2 COB LED

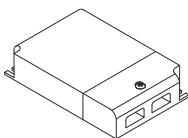





10,5 x 7 x 2,2 cm  7,2 cm SELV    

0129/DALI Dimmer LED

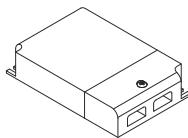
Multipower dimmable driver

IN: 110 - 240V
OUT: 350 mA 1-2 COB LED





10,5 x 7 x 2,2 cm  7,2 cm SELV   05 

0141/DALI

LED driver

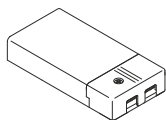
IN: 110 - 240V
OUT: 350 mA, 1-2 COB LED



11,1 x 5,2 x 2,5 cm  5,5 cm

  05 

0141/DIM

LED driver

IN: 110 - 240V
OUT: 350 mA, 1-2 COB LED

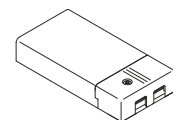

Versione PUSH non sincronizzabile - PUSH version not synchronizable

11,1 x 5,2 x 2,5 cm  5,5 cm    05 

0145 Dimmer LED Maxi

Multipower dimmable driver

IN: 110 - 240V
OUT: 350 mA, 1-3 COB LED

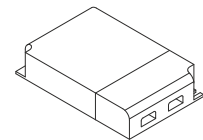

12,3 x 8 x 2,2 cm  8,4 cm SELV    05 

0145/DALI Dimmer LED Maxi

Multipower dimmable driver

IN: 110 - 240V
OUT: 350 mA, 1-3 COB LED

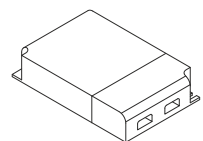

12,3 x 8 x 2,2 cm
 8,4 cm SELV     05 

0133

Cavo di sincronizzazione per dimmer LED
Sincronization cable for dimmer LED
(art. 0129 - art. 0129/DALI - art. 0145 - art. 0145/DALI)
L 150 cm



0726/DIM

LED dimmer

TAGLIO DI FASE (IGBT-TRIAC, TRAILING EDGE-LEADING EDGE)
PHASE CUT-OFF (IGBT-TRIAC, TRAILING EDGE-LEADING EDGE)
IN: 220 - 240V
OUT: 24V - 20W
350 mA, 1-2 COB LED

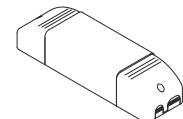



16,5 x 4,5 x 3,5 cm  5,6 cm  IGBT-TRIAC  05 SELV

0733/DIM

LED dimmer

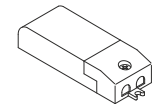
Alimentatori elettronici dimmerabili (IGBT-TRIAC) in corrente continua
Direct current dimmable (TRAILING EDGE-LEADING EDGE) electronic drivers
IN: 220 - 240V
OUT: 350 mA, 1 COB LED



8,7 x 3,8 x 2,1 cm  4,2 cm IGBT-TRIAC  05 SELV

UNITA' DI EMERGENZA LED LED EMERGENCY UNIT

0115/EM

LED Emergency Unit

Kit Inverter + Battery + LED indicator



15,5 x 5,2 x 2,5cm 80cm 13,5 x 4,5 x 2,3cm

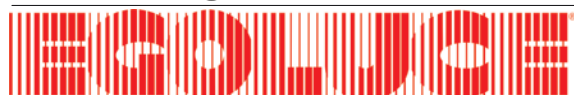

EGOLUCE s.r.l., via I. Newton 12 - 20016 Pero - Milano
telefono +39 02 339586.1 - fax. +39 02 3535112
e-mail: info@egoluce.com - http://www.egoluce.com